

Article number: 201242386A

Description: E+G Retaining magnets with threaded stud GN 52.4-ND-10-M4-E
Neodymium, iron, boron - 80° C, 24N

Measures

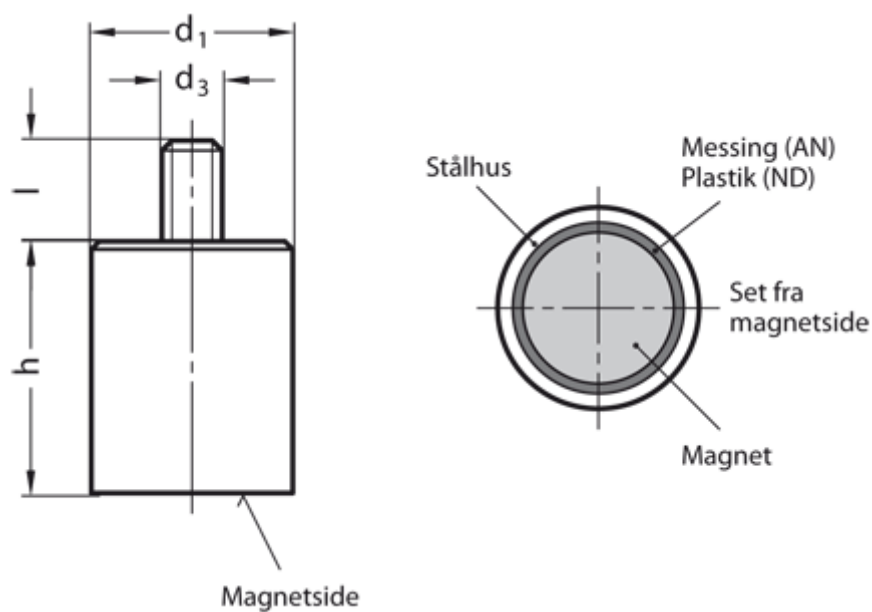

d1	= 10
d3	= M4
h	= 20 ±0,2
Holding force N	= 24.0
l	= 8
Material	= ND Neodym, iron, boron, 80°C